

# RFPT100



## SMD Temperature Compensated Crystal Oscillator for Cospas-Sarsat beacon applications

SMD Temperature Compensated Crystal Oscillator for emergency beacon applications. The TCXO makes use of Rakon's ASIC 'Pluto™' which is a fourth-order crystal oscillator temperature-compensation chip. Pluto™ uses certain patented features, which enables it to achieve the critical medium term stability, previously unattainable with a TCXO. This unique performance for the first time has enabled the use of compact, low-cost TCXOs in emergency beacon applications.

### Product description

An emergency distress beacon is a small battery-powered device that can be carried on board of ships (called EPIRB = Emergency Position Indicating Radio Beacon), aircraft (called ELT = Emergency Locator Transmitter) and on person (called PLB = Personal Locator Beacon). Once activated it transmits a signal that is detectable by rescue authorities. These beacons are regulated by Cospas-Sarsat, an international organisation for search and rescue of persons in distress. The Cospas-Sarsat system uses a constellation of satellites orbiting the globe and a network of earth stations to provide distress alert and location information to rescue teams anywhere in the world. Using the signals transmitted by the beacon, the system calculates its position to within a few km. The beacon's correct operation depends to a great extent on the stability of the reference oscillator that is used to generate the 406.xxx MHz transmitter signal. Traditionally oven controlled crystal oscillators (OCXOs) have been used for this function. However an OCXO needs significant power and time to heat the internal oven whereas the new Rakon TCXO has a power consumption of only 6mW (typ.) and instantaneously provides a stable output frequency. This results in increased battery life or alternatively allows the use of a smaller battery. The smaller battery reduces system cost and allows future beacons to be smaller and lighter.

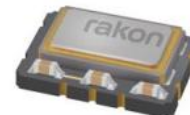

### Applications

- Emergency Beacon
- Other

### Features

- Low power consumption
- COSPAS SARSAT compliant
- Medium term stability 100% tested
- Test data supplied with each unit

### Specifications

#### 1.0 SPECIFICATION REFERENCES

Line	Parameter	Description
1.1	Model description	RFPT100
1.2	RoHS compliant	Yes
1.3	Package size available	7.0mm x 5.0mm (other sizes available upon request)

**2.0 FREQUENCY CHARACTERISTICS**

Line	Parameter	Test Condition	Value	Unit
2.1	Frequency range	Frequency range available 10-20MHz. Standard frequencies: 10, 12.688375, 12.688656, 16.367MHz	10 to 20	MHz
2.2	Calibration tolerance at 25°C	Reference nominal frequency	±0.5 max	ppm
2.3	Stability over temperature		±0.2 max	ppm
2.4	Temperature range	-20°C to 55°C (class II) or -40°C to 55°C (class I)	-40 to 55	°C
2.5	Stability vs. supply voltage changes	±10%, reference to frequency at 3.3V	±0.1 max	ppm
2.6	Stability vs. load changes	±5pF variation, reference to frequency at 15pF	±0.1 max	ppm
2.7	Root allan variance	Tau=100ms	1 max	ppb
2.8	Medium term stability- see note 1	Mean slope dF/dt - steady state conditions	±0.7 max	ppb/min
2.9	Medium term stability- see note 1	Mean slope dF/dt- during and 15 minutes after variable temperature conditions (dT/dt≤±5°C/hour). Max±1.0ppb/min optional (-20°C to 55°C)	±1.7 max	ppb/min
2.10	Medium term stability- see note 1	Residual dF from slope (dT/dt≤±5°C/hour)	±2 max	ppb
2.11	Drift due to reflow soldering		±1 max	ppm
2.12	Long term stability	first year	±1 max	ppm
2.13	Long term stability	10 years	±3 max	ppm

**3.0 POWER SUPPLY**

Line	Parameter	Test Condition	Value	Unit
3.1	Supply voltage, Vs		3 to 3.6	V
3.2	Current	Load 15pF (frequency dependent, typ. 2.5mA at 12.688MHz)	6 max	mA

**4.0 VOLTAGE CONTROL**

Line	Parameter	Test Condition	Value	Unit
4.1	Control voltage range	Without reference voltage; Vs=5.0V	1.5 to 3.5	V
4.2	Control voltage range	Without reference voltage; Vs=3.3V	0.65 to 2.65	V
4.3	Control voltage range	With reference voltage (0 to Vref)		V
4.4	Frequency tuning	Optional: adjustment: frequency ≤20MHz (standard option) ± 5ppm. Optional adjustment: frequency >20MHz (standard option) ±7ppm. Optional: high pulling refer to note 3	5 to 50	ppm
4.5	Port input impedance	Measured between control voltage and GND pin	100	k
4.6	Linearity		1	%
4.7	Slope	Positive		
4.8	Modulation bandwidth		2 min	kHz

**5.0 OSCILLATOR OUTPUT- HCMOS (Vs=3.3V, 15pF Load)**

Line	Parameter	Test Condition	Value	Unit
5.1	Output waveform	HCMOS (other types available upon request)		
5.2	Output voltage low level		0.1 max	Vs
5.3	Output voltage high level		0.9 min	Vs
5.4	Rise and fall times	10 to 90%	8	ns
5.5	Duty cycle	At 50%	45 to 55	%
5.6	Load		10 to 20	pF

**6.0 OSCILLATOR OUTPUT- Clipped sinewave**

Line	Parameter	Test Condition	Value	Unit
6.1	Output waveform	Clipped sinewave, AC-coupled		
6.2	Output level		0.8 min	Vpp
6.3	Output load resistance		9 to 11	k
6.4	Output load capacitance		9 to 11	pF

**7.0 SSB PHASE NOISE**

Line	Parameter	Test Condition	Value	Unit
7.1	SSB phase noise power density at 10Hz offset	Typical values for a 12.688MHz oscillator at 25°C	-90	dBc/Hz
7.2	SSB phase noise power density at 100Hz offset	Typical values for a 12.688MHz oscillator at 25°C	-115	dBc/Hz
7.3	SSB phase noise power density at 1kHz offset	Typical values for a 12.688MHz oscillator at 25°C	-127	dBc/Hz
7.4	SSB phase noise power density at 10kHz offset	Typical values for a 12.688MHz oscillator at 25°C	-137	dBc/Hz
7.5	SSB phase noise power density at 100kHz offset	Typical values for a 12.688MHz oscillator at 25°C	-143	dBc/Hz

**8.0 TRISTATE CONTROL**

Line	Parameter	Description
8.1	Output enabled	Tri-state control pad open circuit or $\geq 0.6V_s$ . Output enabled
8.2	Output tristate	Tri-state control pad $\leq 0.2V_s$ . Output high impedance

**9.0 ENVIRONMENTAL**

Line	Parameter	Description
9.1	Vibration	IEC 60068-2-6, test Fc, 10-60Hz 1.5 mm displacement, 60-2000Hz at 10gn, 30 minutes in each of three mutually perpendicular axes at 1 octave per minute
9.2	Shock	IEC 60068-2-27, test Ea: 1500gn acceleration for 0.5ms duration, Half-sine pulse, 3 shocks in each direction along three mutually perpendicular axes
9.3	Soldering	SMD product suitable for reflow soldering. See reflow profile
9.4	RoHS	Parts are fully compliant with the European Union directive 2002/95/EC on the restriction of the use of certain hazardous substances in electrical and electronic equipment. Note these RoHS compliant parts are suitable for assembly using both lead-free solders and tin/lead solders
9.5	Storage temperature range	-55 to 125°C

**10.0 PIN CONNECTIONS**

Line	Parameter	Description
10.1	Pin 1	Do not connect
10.2	Pin 2	NC
10.3	Pin 3	Do not connect
10.4	Pin 4	GND
10.5	Pin 5	RF Output
10.6	Pin 6	NC
10.7	Pin 7	NC
10.8	Pin 8	Tri-state Control (Enable)*
10.9	Pin 9	Supply, +Vs
10.10	Pin 10	Do not connect
10.11	*	Leave unconnected if not required

**11.0 MARKING**

Line	Parameter	Description
11.1	Type	Laser marked
11.2	Line 1	R and manufacturing identifier (X XX)
11.3	Line 2	Pad 1 / static sensitivity identifier ( $\Delta$ ), abbreviated part number (0000), device date code (YW), serial number (nnnn)

**12.0 MANUFACTURING INFORMATION**

Line	Parameter	Description
12.1	Reflow soldering	Solder reflow processes as per reflow profile diagram. Solderability: MIL-STD-202, method 208, category 3
12.2	Packaging description	Part numbers with suffix 'T' will be supplied on tape & reel

**13.0 NOTES**

Line	Parameter	Description
13.1	1	Specified and measured according to COSPAS SARSAT 406MHz distress beacons specification T.001 & T.007 (averaged over 18 measurements in 15 minute period, and following 15 minute power up period). Test results shipped with each device, identified by date and serial number, retained for 10 years

Drawing Name: RFPT100 Model Drawing

MODEL DRAWING

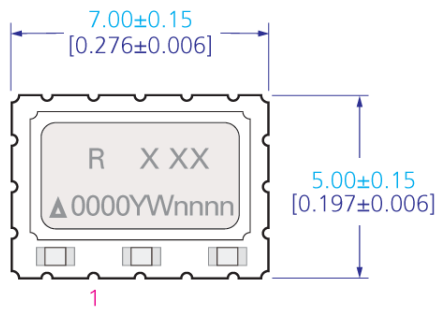

TOP VIEW

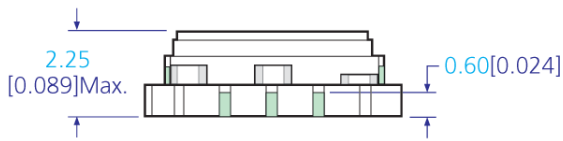

SIDE VIEW

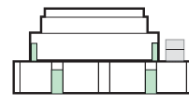

END VIEW

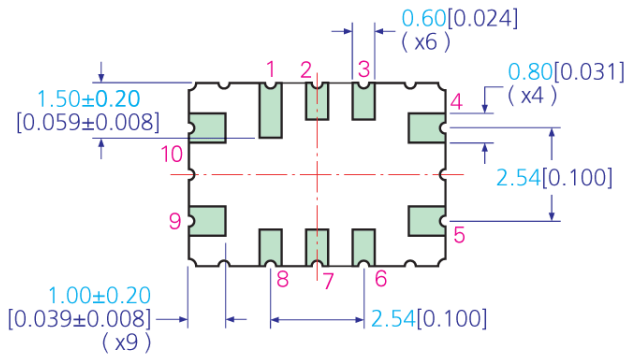

BOTTOM VIEW

NOTE: Pin connections are detailed in the specification

RECOMMENDED PAD LAYOUT - TOP VIEW

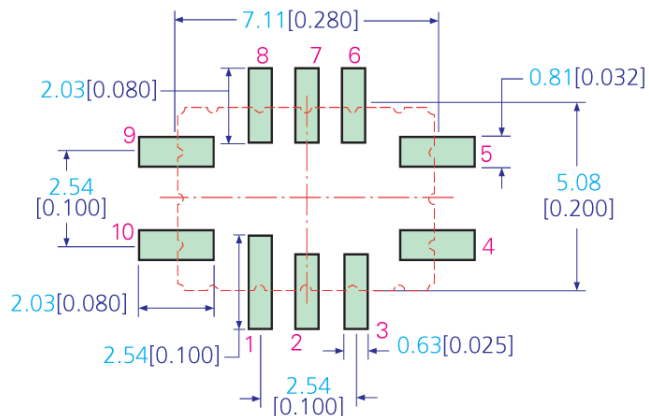

TITLE: RFPT100 MODEL OUTLINE DRAWING

FILENAME: RFPT100\_MD

RELATED DRAWINGS:

REVISION: A

DATE: 22-Jul-10

SCALE: 5 : 1

Millimeters [inch]

Tolerance:

XX = ±0.5

X.X = ±0.2

X.XX = ±0.10

X.XXX = ±0.05

X° = ±1.0°

Hole = ±0.10



©2009 Rakon Limited

Drawing Name: RFPT100 Reflow Profile

Pb-Free Reflow Soldering Profile \*

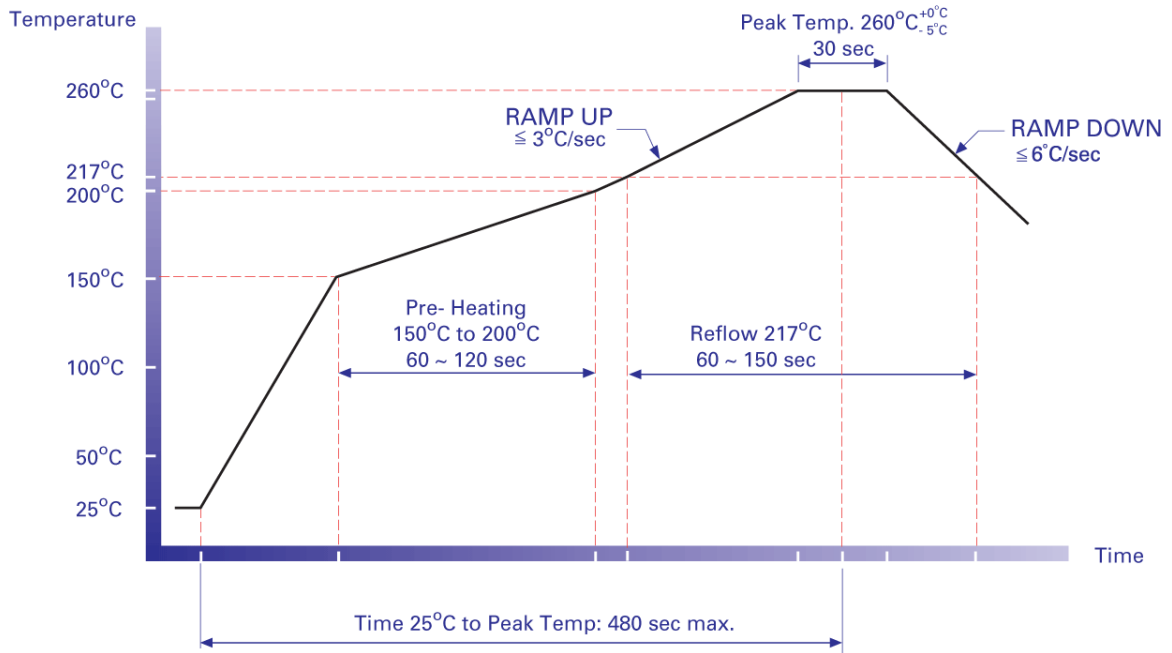

\* NOTE:

This profile was used during the qualification testing of the product and therefore represents worst case conditions. It is not recommended for use by the customer in the actual assembly of these parts.

TITLE: RFPT100 SERIES REFLOW PROFILE

FILENAME: RFPT100\_RF

RELATED DRAWINGS:

REVISION: B

DATE: 09-Sep-10

SCALE: NTS

Millimeters [inch]

Tolerance:

XX = ±0.5

X.X = ±0.2

X.XX = ±0.10

X.XXX = ±0.05

X° = ±1.0°

Hole = ±0.10

**rakon**

©2009 Rakon Limited

## Specification History

**Current Version : 1.01**

Version	User	Change	Note	Date
---------	------	--------	------	------