

## SMD Communication Crystal

Low profile SMD AT-cut quartz crystal in a ceramic package with a 2.0 mm x 1.6 mm foot print.



### Product description

Miniature low profile AT-cut quartz crystal. True SMD style, ceramic package with nickel plated lid, seam welded. The product is supplied on tape and reel.

### Applications

- Automotive
- GPS
- Communications
- Feature phone
- Consumer

### Features

- Low aging
- Low hysteresis
- Wide temperature range

### Specifications

#### 1.0 SPECIFICATION REFERENCE

Line	Parameter	Description
1.1	Model description	RSX-11
1.2	RoHS compliant	Yes
1.3	Reference number	
1.4	Rakon part number	

#### 2.0 FREQUENCY CHARACTERISTICS

Line	Parameter	Test Condition	Value	Unit
2.1	Frequency		19.2 to 52	MHz
2.2	Calibration tolerance	Frequency at 25°C ±2°C and specified load capacitance	±10 to 50	ppm
2.3	Reflow shift	Two consecutive reflows as per attached profile after 4 hours recovery at 25°C	±1 max	ppm
2.4	Frequency stability over temperature	Referenced to frequency reading at 25°C and the specified load capacitance	±15 to 50	ppm
2.5	Temperature range	Operating temperature	-40 to 85	°C
2.6	Frequency perturbations	Peak-to-peak deviation from the frequency versus temperature curve fit 5th order. Minimum of 1 frequency reading every 3°C over operating temperature range	1 max	ppm
2.7	Long term stability	Frequency drift over 1 year at 25°C	±1 max	ppm
2.8	g sensitivity	Gamma vector of all three axes from 30 Hz to 1500 Hz at 10 RMS	2 max	ppb/g

#### 3.0 ELECTRICAL

Line	Parameter	Test Condition	Value	Unit
3.1	Load capacitance (CL)	Frequency is calibrated at room temperature	5 to 32	pF
3.2	Shunt capacitance (C0)	Operating specification	0.5 to 3	pF
3.3	Pull ability	Load and frequency dependant	0.5 min	ppm/pF
3.4	Drive level	Operating specification	30 max	µW
3.5	Equivalent series resistance (ESR)		85 max	Ω
3.6	Insulation resistance (IR)	100V ±15V at 25°C	500 min	MΩ

#### 4.0 ENVIRONMENTAL

Line	Parameter	Description
4.1	Shock	Half sine-wave acceleration of 3000g peak amplitude. Duration: 0.3ms, Velocity: 12.3ft/s [MIL-STD-202 M213]
4.2	Moisture resistance	1000 hours at 85°C, 85% Relative Humidity. Biased. [MIL-STD-202 M106G]
4.3	Temperature cycling	1000 temperature cycles, where each cycle consists of a 25 minute soak time at -45°C followed by a 25 minute soak time at 85°C, with a 60 second maximum transition time between temperatures. Air to air transition. [JESD22 METHOD JA-104C]
4.4	Vibration	5g for 20 minutes. 12 cycles in each of 3 orientations. Test from 10-2000 Hz [JESD22-B103-B]
4.5	Storage temperature	-55 to 105°C

#### 5.0 ENVIRONMENTAL

Line	Parameter	Description
5.1	Shock	2 cycle drop it onto concrete for six directions (x, y, z) and one corner. The height is 152 cm. Dummy is 120g weight.
5.2	Moisture Resistance	Temperature: 40°C ±2°C; Humidity : 90 ~ 95%; Time : for 240 hours; According to IEC 1178-1.4.8.15
5.3	Thermal Shock	100 temperature cycles, where each cycle consists of a 25 minute soak time at -40°C followed by a 25 minute soak time at 85°C, with a 60 second maximum transition time between temperatures. Air to air transition. According to IEC 1178-1.4.8.4
5.4	Vibration	Frequency: 10 ~ 55 Hz; Amplitude: 1.5 mm; Period: 1 min; Test time: X,Y,Z each direction 2h; According to IEC 1178-1.4.8.7
5.5	Storage temperature	-40 to 85°C

#### 6.0 MANUFACTURING INFORMATION

Line	Parameter	Description
6.1	Washing	Able to withstand aqueous washing processes
6.2	Reflow	Able to withstand forced convection reflow process. Refer to "RSX/RGX crystals Pb-free Reflow" drawing
6.3	Packaging description	Tape and reel. Standard packing quantity is 4000 units per reel

#### 7.0 MARKING

Line	Parameter	Description
7.1	Package	2.0 x 1.6 mm
7.2	Type	Laser engraved
7.3	Line 1	[R], [XX.XX]* = Frequency in MHz (e.g.: 8.000 = 8MHz, 19.20 = 19.2MHz, 100.0 = 100MHz)
7.4	Line 2	[o] = Pin 1, [F] = Factory code, [YMD] = Date code
7.5	* Frequency code	Frequency marking is only represented by the first four significant digits. For example, on a RSX-11 at 16.368MHz, its frequency marking will be 16.36MHz

# Drawing Name: RSX-11 Model Drawing

## MODEL OUTLINE

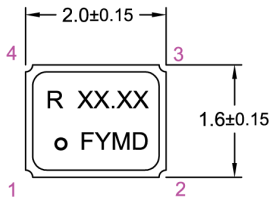

TOP VIEW

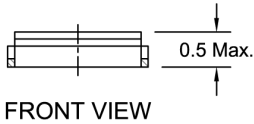

FRONT VIEW

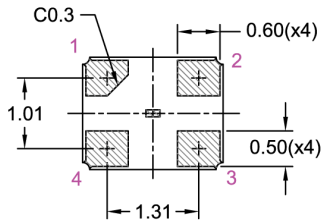

BOTTOM VIEW

## MARKING EXAMPLE

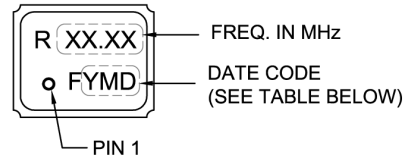

## PIN CONNECTIONS

CONNECTIONS	
1	CRYSTAL
2	GND
3	CRYSTAL
4	GND

## RECOMMENDED PAD LAYOUT - TOP VIEW

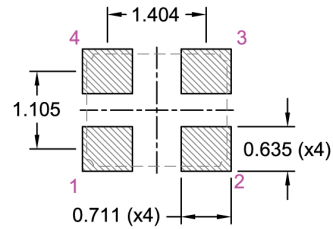

### Y - Year Code

Code	Year	Code	Year
A	2010	N	2023
B	2011	O	2024
C	2012	P	2025
D	2013	Q	2026
E	2014	R	2027
F	2015	S	2028
G	2016	T	2029
H	2017	U	2030
I	2018	V	2031
J	2019	W	2032
K	2020	X	2033
L	2021	Y	2034
M	2022	Z	2035

### M - Month Code

Code	Month
1	Jan
2	Feb
3	Mar
4	Apr
5	May
6	Jun
7	Jul
8	Aug
9	Sep
A	Oct
B	Nov
C	Dec

### D - Day Code

Code	Day	Code	Day	Code	Day
1	1	E	14	R	27
2	2	F	15	S	28
3	3	G	16	T	29
4	4	H	17	U	30
5	5	I	18	V	31
6	6	J	19		
7	7	K	20		
8	8	L	21		
9	9	M	22		
A	10	N	23		
B	11	O	24		
C	12	P	25		
D	13	Q	26		

TITLE: RSX-11 MODEL

RELATED DRAWINGS:

FILENAME: CAT482

REVISION: E

DATE: 17-Oct-12

SCALE: 10 : 1

Millimetres

TOLERANCES:

XX =

X.X = ±0.2

X.XX = ±0.10

X.XXX = ±0.05

X° =

Hole =

**rakon**

© 2009 Rakon Limited

# Drawing Name: RSX-11 Tape & Reel

## TAPE DETAIL (Scale 5 : 1)

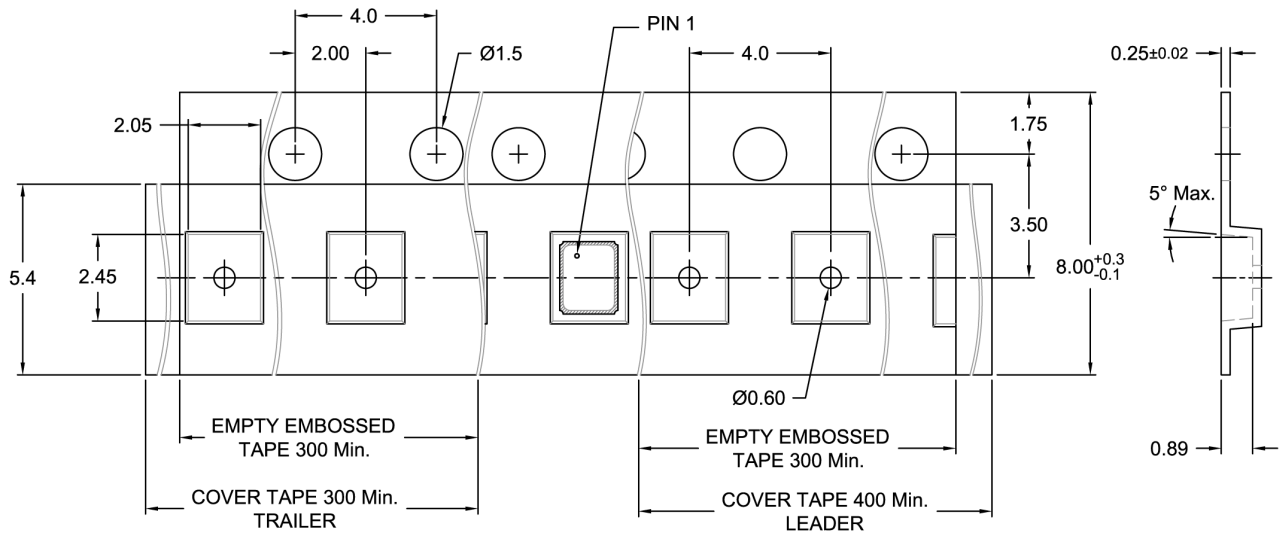

## REEL DETAIL (Scale 1 : 2.5)

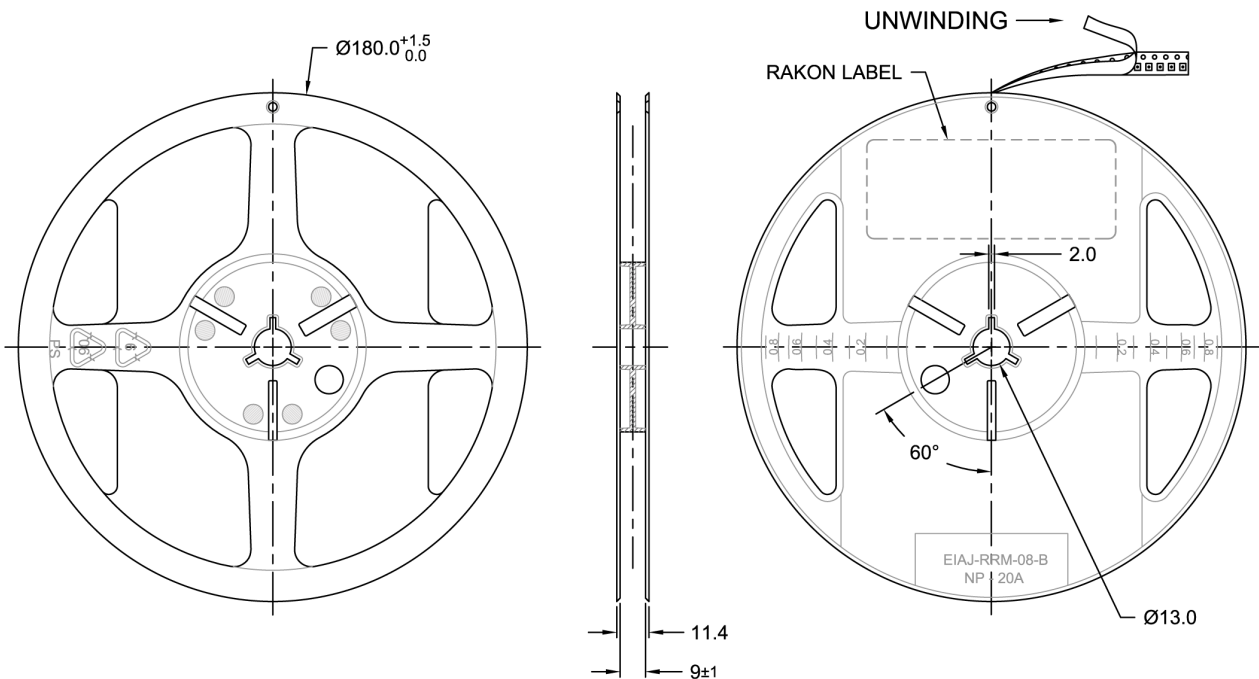

TITLE: 2016 SERIES CRYSTAL TAPE & REEL

RELATED DRAWINGS:

FILENAME: CAT518

REVISION: D

DATE: 22-Sep-11

SCALE: 5 : 1

Millimetres

TOLERANCES:

XX =

X.X =  $\pm 0.1$

X.XX =  $\pm 0.05$

X.XXX =

X° =

Hole =

**rakon**

© 2009 Rakon Limited

**Drawing Name: RSX/RGX Crystals Pb-free Reflow**

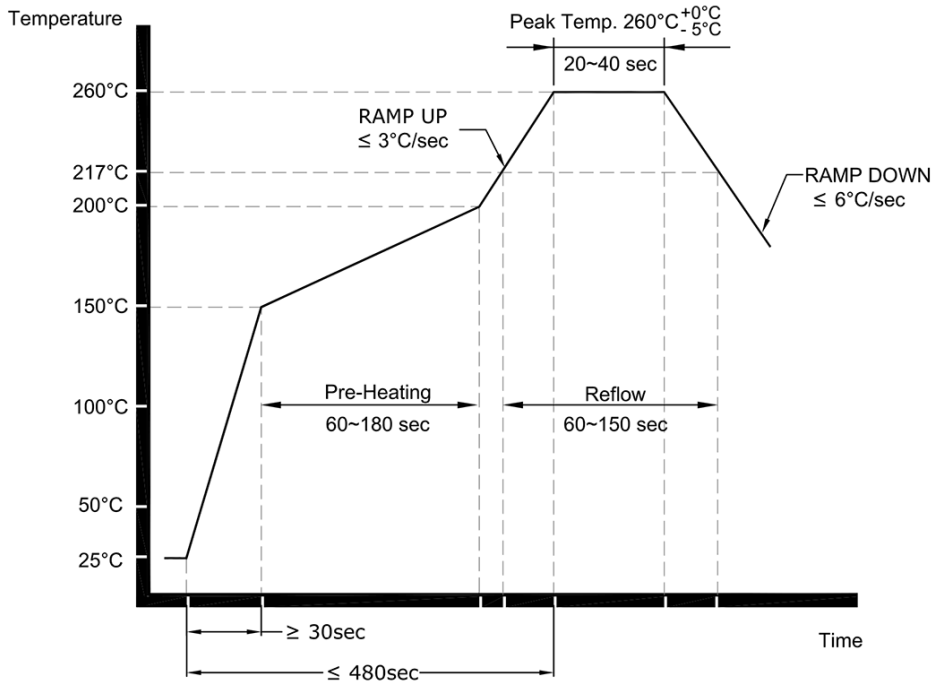

**NOTE:**

The product has been tested to withstand the Reflow Profile shown. The Reflow Profile used to solder Rakon RSX/RGX crystals are determined by the solder paste Manufacturer's specification. It is recommended that the Reflow Profile used does not exceed the one shown above.

TITLE: CRYSTAL Pb-FREE REFLOW

FILENAME: CAT353

RELATED DRAWINGS:

REVISION: B

DATE: 01-Feb-07

SCALE: NTS

Millimetres

**rakon**

© 2009 Rakon Limited