

SMD Communication Crystal

Low profile SMD AT-cut quartz crystal with thermally coupled temperature sensor in a ceramic package with a 2.0 mm x 1.6 mm foot print.

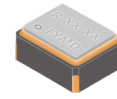

Product description

Miniature low profile AT-cut quartz crystal with thermally coupled temperature sensor. True SMD style, ceramic package with nickel plated lid, seam welded. The product is supplied on tape and reel.

Applications

- Automotive
- Communications
- GPS
- Mobile phones
- Wi-Fi

Features

- Low aging
- Excellent shock and vibration performance
- Thermally coupled temperature sensor

Specifications

1.0 SPECIFICATION REFERENCE

Line	Parameter	Description
1.1	Model description	RXT2016AT
1.2	RoHS compliant	Yes
1.3	Reference number	
1.4	Rakon part number	

2.0 FREQUENCY CHARACTERISTICS

Line	Parameter	Test Condition	Value	Unit
2.1	Frequency		19.2 to 52	MHz
2.2	Calibration tolerance	Frequency at 25°C ±2°C and specified load capacitance	±10 to 50	ppm
2.3	Reflow shift	Frequency shift after reflow with 4 hours settling at 25°C	±1 max	ppm
2.4	Frequency stability over temperature	Referenced to frequency reading at 25°C and the specified load capacitance	±12 to 50	ppm
2.5	Temperature range	Operating temperature	-40 to 85	°C
2.6	Frequency perturbations	Residual error from the frequency versus temperature curve fit 5th order. Minimum of 1 frequency reading every 3°C over the operating temperature range	±0.5 max	ppm
2.7	Long term stability	Frequency drift over 1 year at 25°C	±1 to 2	ppm
2.8	G sensitivity	Gamma vector of all three axes from 30Hz to 1500Hz at 10 RMS	2 max	ppb/g

3.0 ELECTRICAL

Line	Parameter	Test Condition	Value	Unit
3.1	Load capacitance (CL)	Frequency is calibrated at room temperature	5 to 32	pF
3.2	Shunt capacitance (C0)	Operating specification	0.5 to 3	pF
3.3	Pullability	Load and frequency dependent	0.5 min	ppm/pF
3.4	Drive level	Operating specification	100 max	µW
3.5	Equivalent series resistance (ESR)		85 max	Ω
3.6	Insulation resistance (IR)	100V ±15V at 25°C	500 min	MΩ

4.0 FREQUENCY VS TEMPERATURE CURVE FIT COEFFICIENTS

Line	Parameter	Test Condition	Value	Unit
4.1	Inflection temperature (T0)	Reference temperature for calculation of 3rd order coefficients	28 to 32	°C
4.2	First order coefficient	Typical value using third order curve fitting referenced to T0. Calculated over the operating temperature range. TBD		
4.3	Second order coefficient	Typical value using third order curve fitting referenced to T0. Calculated over the operating temperature range. TBD		
4.4	Third order coefficient	Typical value using third order curve fitting referenced to T0. Calculated over the operating temperature range. TBD		

5.0 TEMPERATURE SENSOR CHARACTERISTICS

Line	Parameter	Test Condition	Value	Unit
5.1	Resistance (Ro)	Resistance at 25°C (To)	10 to 100	kΩ
5.2	Resistance tolerance		±1 max	%
5.3	Beta constant (25 - 50°C) 10kΩ	Calculated between two specified temperatures points R and Ro. T and To are absolute temperature (K). $\text{Beta} = \ln(R/R_o) / (1/T - 1/To)$	3380	K
5.4	Beta constant (25 - 50°C) 100kΩ	Calculated between two specified temperatures points R and Ro. T and To are absolute temperature (K). $\text{Beta} = \ln(R/R_o) / (1/T - 1/To)$	4250	K
5.5	Beta tolerance		±1 max	%
5.6	Thermistor size	0201		

6.0 ENVIRONMENTAL

Line	Parameter	Description
6.1	Shock	Half sine-wave acceleration of 3000g peak amplitude. Duration: 0.3ms, Velocity: 12.3 ft/s [MIL-STD-202 M213]
6.2	Moisture resistance	1000 hours at 85°C, 85% Relative Humidity. Biased. [MIL-STD-202 M106G]
6.3	Temperature cycling	1000 temperature cycles, where each cycle consists of a 25 minute soak time at -40°C followed by a 25 minute soak time at 85°C, with a 60 second maximum transition time between temperatures. Air to air transition. [JESD22 METHOD JA-104C]
6.4	Vibration	5g for 20 minutes. 12 cycles in each of 3 orientations. Test from 10-2000Hz [JESD22-B103-B]
6.5	Storage temperature	-40 to 105°C

7.0 MANUFACTURING INFORMATION

Line	Parameter	Description
7.1	Washing	Able to withstand aqueous washing process
7.2	Reflow	Able to withstand reflow process
7.3	Packaging description	Tape and reel. Standard packing quantity is 3000 units per reel

8.0 MARKING

Line	Parameter	Description
8.1	Type	Laser engraved
8.2	Line 1	R and frequency in MHz [XX.XX]
8.3	Line 2	Pin 1 and date code

Drawing Name: RXT2016 Model Drawing

MODEL OUTLINE

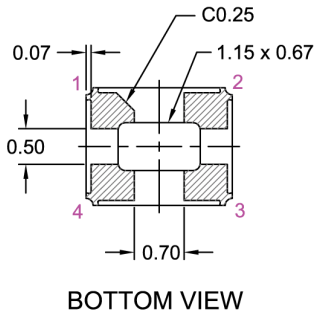
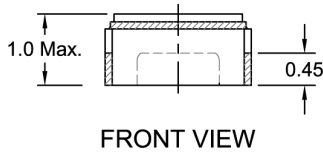
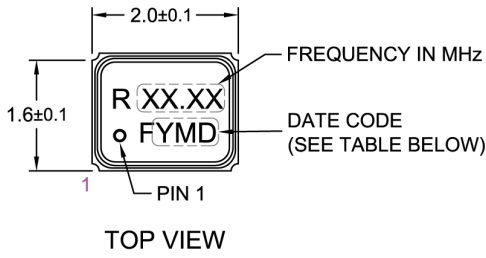

EQUIVALENT CIRCUIT - TOP VIEW

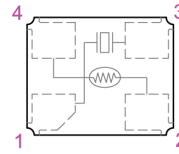

PIN CONNECTIONS

1	CRYSTAL
2	GND
3	CRYSTAL
4	THERM

RECOMMENDED PAD LAYOUT - TOP VIEW

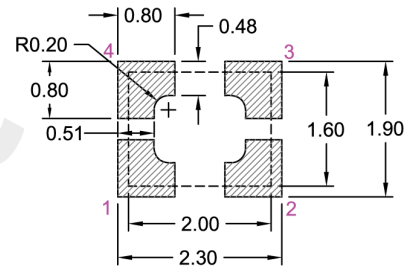

Y - Year Code

Code	Year	Code	Year
A	2010	N	2023
B	2011	O	2024
C	2012	P	2025
D	2013	Q	2026
E	2014	R	2027
F	2015	S	2028
G	2016	T	2029
H	2017	U	2030
I	2018	V	2031
J	2019	W	2032
K	2020	X	2033
L	2021	Y	2034
M	2022	Z	2035

M - Month Code

Code	Month
1	Jan
2	Feb
3	Mar
4	Apr
5	May
6	Jun
7	Jul
8	Aug
9	Sep
A	Oct
B	Nov
C	Dec

D - Day Code

Code	Day	Code	Day	Code	Day
1	1	E	14	R	27
2	2	F	15	S	28
3	3	G	16	T	29
4	4	H	17	U	30
5	5	I	18	V	31
6	6	J	19		
7	7	K	20		
8	8	L	21		
9	9	M	22		
A	10	N	23		
B	11	O	24		
C	12	P	25		
D	13	Q	26		

TITLE: RXT2016AT MODEL

RELATED DRAWINGS:

FILENAME: CAT681

REVISION: A

DATE: 18-Apr-12

SCALE: 10 : 1

Millimetres

TOLERANCES:

XX =

X.X =

X.XX = ±0.10

X.XXX = ±0.05

X° =

Hole =

rakon

© 2009 Rakon Limited

Drawing Name: RXT2520AT Series Electrical Circuit

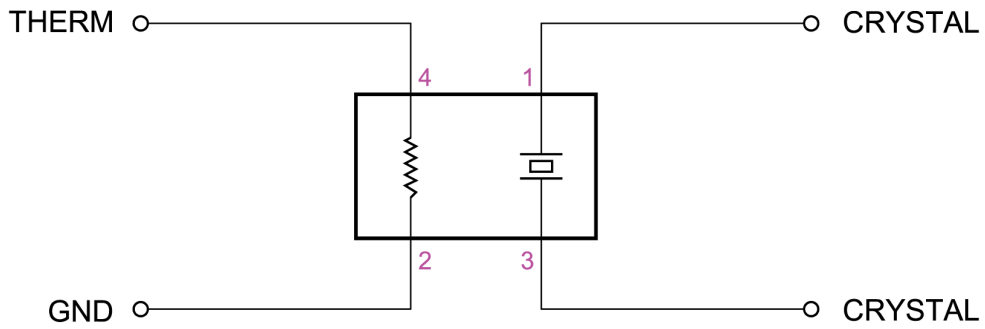

TITLE: RXT-AT SERIES ELECTRICAL CIRCUIT

RELATED DRAWINGS:

FILENAME: CAT590

REVISION: D

DATE: 18-Apr-12

SCALE: NTS

Millimetres

rakon

© 2009 Rakon Limited

Drawing Name: Pb-Free Reflow

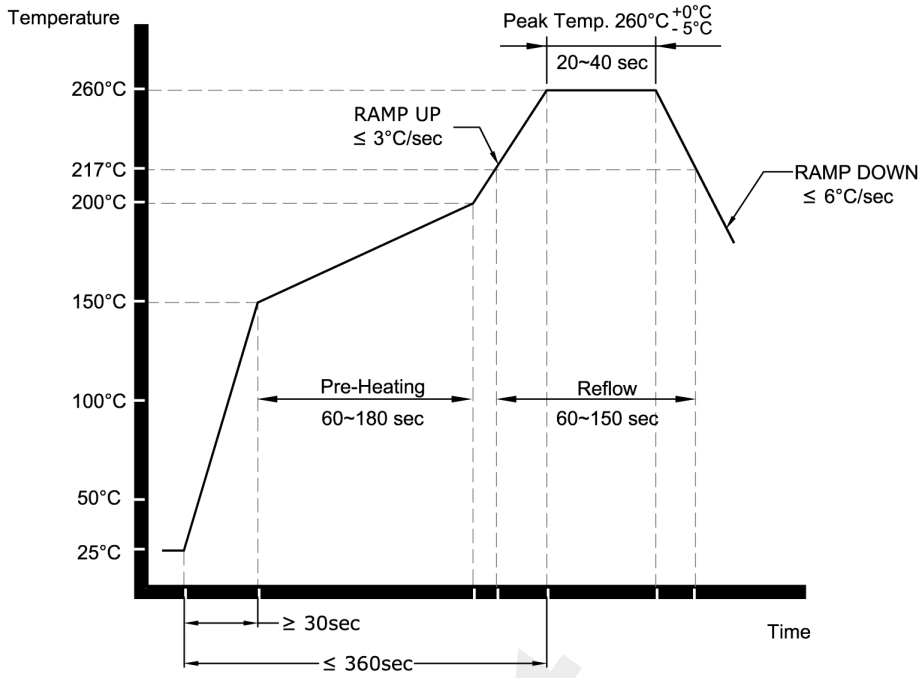

NOTE:

The product has been tested to withstand the Reflow Profile shown. The Reflow Profile used to solder Rakon products is determined by the solder paste Manufacturer's specification. It is recommended that the Reflow Profile used does not exceed the one shown above.

TITLE: Pb-FREE REFLOW

RELATED DRAWINGS:

FILENAME: CAT541

REVISION: B

DATE: 05-Sep-11

SCALE: NTS

Millimetres

rakon

© 2009 Rakon Limited